

## DIO7003

### 5.5V Low Loss Power Distribution Switch

#### Features

- Input voltage: 2.7V to 5.5V
- Typical 75mΩ on-resistance
- Five different continuous current versions
- Under voltage lockout
- Over current protection, short circuit protection and over temperature protection
- Fault time 5ms typically with blanking
- Reverse blocking (no body diode)
- No reverse current when power ON or power OFF
- Enable polarity: active high or active low
- Compact SOT23-5, SOIC-8, EP-MSOP8 and MSOP-8 packages

#### Applications

- USB Ports/Hubs
- Digital TV
- Set-Top Boxes
- VOIP Phones

#### Descriptions

The DIO7003 power distribution switch is intended for applications where precision current limiting is required or heavy capacitive loads and short circuits are encountered. The power switch rising and falling times are controlled to minimize current surges during turning on/off.

The DIO7003A/B/C/D/E provide separately 350mA/700mA/1A/1.5A/2A five current levels.

The DIO7003 device limits the output current under a safe level by using a constant current mode when the output load exceeds the current limit threshold.

The DIO7003 is available in the SOT23-5, SOIC-8, EP-MSOP8 and MSOP-8 packages. It is rated over the -40°C to 85°C temperature range.

#### Typical Application

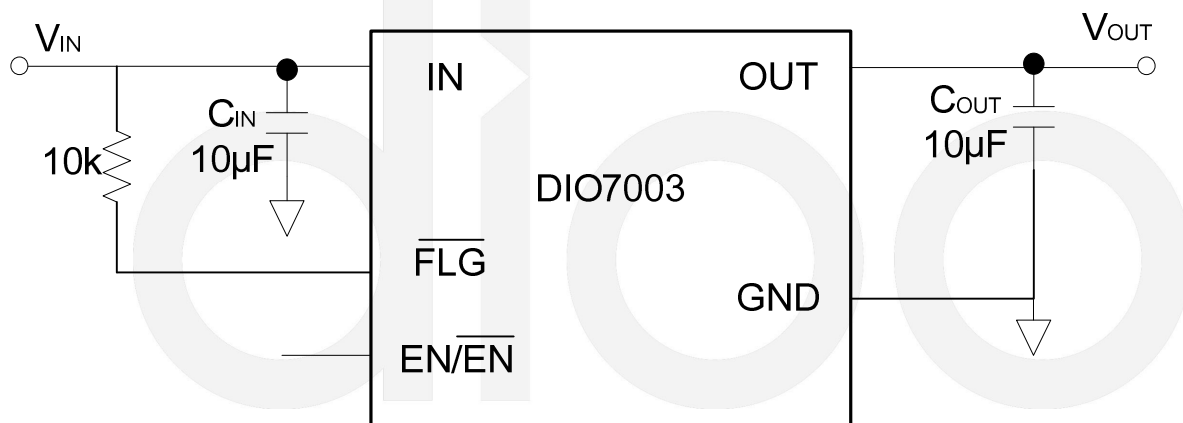



# DIO7003

5.5V Low Loss Power Distribution Switch

## Ordering Information

Order Part Number	Top Marking	Recommended Continuous Current	EN/ $\overline{\text{EN}}$		Package	
DIO7003HAST5	W3HA	350mA	Active High	Green	SOT23-5	Tape & Reel, 3000
DIO7003HBST5	W3HB	700mA	Active High	Green	SOT23-5	Tape & Reel, 3000
DIO7003HCST5	W3HC	1A	Active High	Green	SOT23-5	Tape & Reel, 3000
DIO7003HDST5	W3HD	1.5A	Active High	Green	SOT23-5	Tape & Reel, 3000
DIO7003HEST5	W3HE	2A	Active High	Green	SOT23-5	Tape & Reel, 3000
DIO7003LAST5	W3LA	350mA	Active Low	Green	SOT23-5	Tape & Reel, 3000
DIO7003LBST5	W3LB	700mA	Active Low	Green	SOT23-5	Tape & Reel, 3000
DIO7003LCST5	W3LC	1A	Active Low	Green	SOT23-5	Tape & Reel, 3000
DIO7003LDST5	W3LD	1.5A	Active Low	Green	SOT23-5	Tape & Reel, 3000
DIO7003LEST5	W3LE	2A	Active Low	Green	SOT23-5	Tape & Reel, 3000
DIO7003HASO8	D703HA	350mA	Active High	Green	SOIC-8	Tape & Reel, 2500
DIO7003HBSO8	D703HB	700mA	Active High	Green	SOIC-8	Tape & Reel, 2500
DIO7003HCSO8	D703HC	1A	Active High	Green	SOIC-8	Tape & Reel, 2500
DIO7003HDSO8	D703HD	1.5A	Active High	Green	SOIC-8	Tape & Reel, 2500
DIO7003HESO8	D703HE	2A	Active High	Green	SOIC-8	Tape & Reel, 2500
DIO7003LASO8	D703LA	350mA	Active Low	Green	SOIC-8	Tape & Reel, 2500
DIO7003LBSO8	D703LB	700mA	Active Low	Green	SOIC-8	Tape & Reel, 2500
DIO7003LCSO8	D703LC	1A	Active Low	Green	SOIC-8	Tape & Reel, 2500
DIO7003LDSO8	D703LD	1.5A	Active Low	Green	SOIC-8	Tape & Reel, 2500
DIO7003LESO8	D703LE	2A	Active Low	Green	SOIC-8	Tape & Reel, 2500
DIO7003HAXM8	D703HA	350mA	Active High	Green	EP-MSOP8	Tape & Reel, 3000
DIO7003HBXM8	D703HB	700mA	Active High	Green	EP-MSOP8	Tape & Reel, 3000
DIO7003HCXM8	D703HC	1A	Active High	Green	EP-MSOP8	Tape & Reel, 3000
DIO7003HDXM8	D703HD	1.5A	Active High	Green	EP-MSOP8	Tape & Reel, 3000
DIO7003HEXM8	D703HE	2A	Active High	Green	EP-MSOP8	Tape & Reel, 3000
DIO7003LAXM8	D703LA	350mA	Active Low	Green	EP-MSOP8	Tape & Reel, 3000
DIO7003LBXM8	D703LB	700mA	Active Low	Green	EP-MSOP8	Tape & Reel, 3000
DIO7003LCXM8	D703LC	1A	Active Low	Green	EP-MSOP8	Tape & Reel, 3000
DIO7003LDXM8	D703LD	1.5A	Active Low	Green	EP-MSOP8	Tape & Reel, 3000
DIO7003LEXM8	D703LE	2A	Active Low	Green	EP-MSOP8	Tape & Reel, 3000
DIO7003HAMP8	D703HA	350mA	Active High	Green	MSOP-8	Tape & Reel, 3000
DIO7003HBMP8	D703HB	700mA	Active High	Green	MSOP-8	Tape & Reel, 3000
DIO7003HCMP8	D703HC	1A	Active High	Green	MSOP-8	Tape & Reel, 3000
DIO7003HDMP8	D703HD	1.5A	Active High	Green	MSOP-8	Tape & Reel, 3000
DIO7003HEMP8	D703HE	2A	Active High	Green	MSOP-8	Tape & Reel, 3000



# DIO7003

5.5V Low Loss Power Distribution Switch

DIO7003LAMP8	D703LA	350mA	Active Low	Green	MSOP-8	Tape & Reel, 3000
DIO7003LBMP8	D703LB	700mA	Active Low	Green	MSOP-8	Tape & Reel, 3000
DIO7003LCMP8	D703LC	1A	Active Low	Green	MSOP-8	Tape & Reel, 3000
DIO7003LDMP8	D703LD	1.5A	Active Low	Green	MSOP-8	Tape & Reel, 3000
DIO7003LEMP8	D703LE	2A	Active Low	Green	MSOP-8	Tape & Reel, 3000

## Ordering Information Complimentary Note

Ordering number = Part No. + Enable Active Version + Continuous Current Version + Package Code

DIO7003

H: Enable Active High  
L: Enable Active Low

ST5: Stands for SOT23-5  
SO8: Stands for SOIC-8  
XM8: Stands for EP-MSOP8  
MP8: Stands for MSOP-8

A: 350mA Continuous Current Version  
B: 700mA Continuous Current Version  
C: 1A Continuous Current Version  
D: 1.5A Continuous Current Version  
E: 2A Continuous Current Version



## Pin Assignments

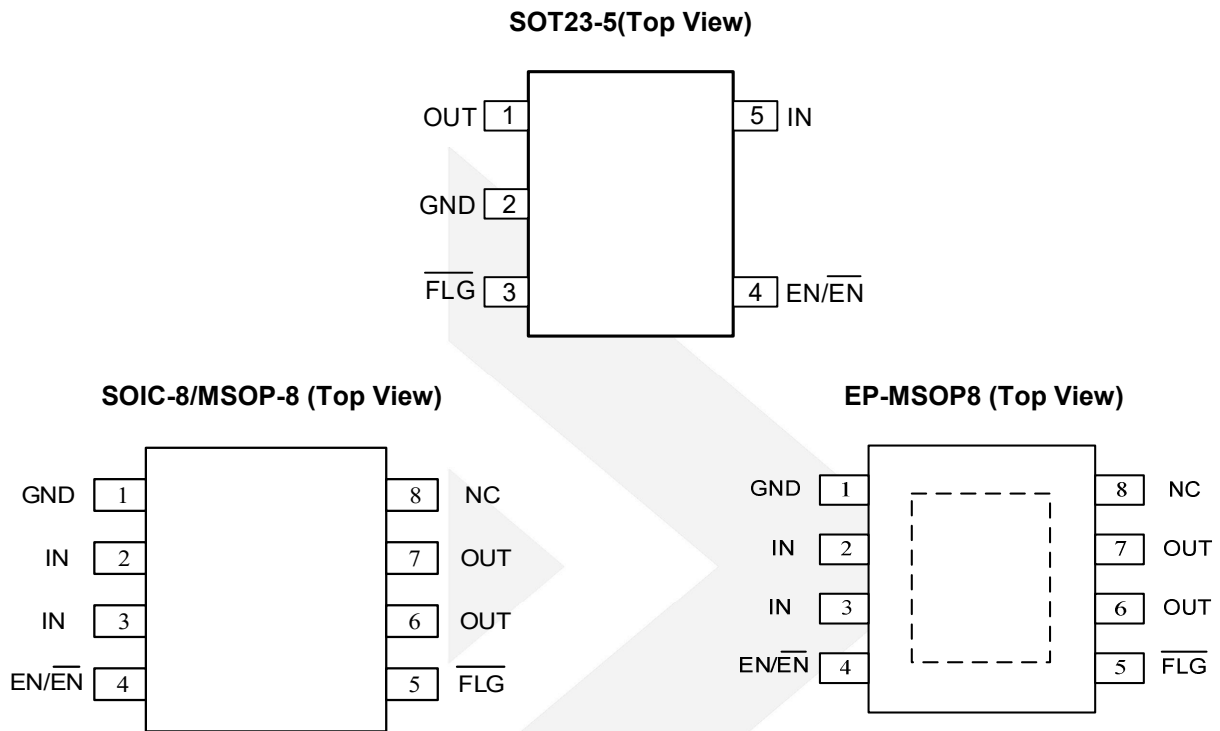

Figure 1 Pin Assignment

## Pin Description

Pin Name	Pin Description
OUT	Output pin, decoupled with a 10 $\mu$ F capacitor to GND
GND	Ground pin
$\overline{\text{FLG}}$	Fault flag output
EN/ $\overline{\text{EN}}$	Active high or Active low. Do not leave it floating
IN	Input pin, decoupled with a 10 $\mu$ F capacitor to GND



# DIO7003

5.5V Low Loss Power Distribution Switch

## Absolute Maximum Ratings

Stresses beyond those listed under "Absolute Maximum Rating" may cause permanent damage to the device. These are stress ratings only and functional operation of the device at these or any other condition beyond those indicated in the operational sections of the specifications is not implied. Exposure to absolute maximum rating conditions for extended periods may affect device reliability.

Parameter		Rating	Unit
All pins		-0.3 to 6	V
Package Thermal Resistance	$\theta_{JA}$ , SOT23-5	250	°C/W
	$\theta_{JA}$ , SOIC-8	130	
	$\theta_{JA}$ , EP-MSOP8	100	
	$\theta_{JA}$ , MSOP-8	166	
Junction Temperature Range		150	°C
Lead Temperature (Soldering, 10 sec)		260	°C
Storage Temperature Range ( $T_{STG}$ )		-65 to 150	°C
ESD Susceptibility	HBM (Human Body Mode)	6	kV
	CDM (Charged Device Mode)	2	

Note: Input and output negative ratings may be exceeded if input and output diode current ratings are observed.

## Recommended Operating Conditions

The Recommended Operating Conditions table defines the conditions for actual device operation to ensure optimal performance to the datasheet specifications. DIOO does not recommend exceeding them or designing to Absolute Maximum Ratings.

Parameter		Rating	Unit
IN		2.7 to 5.5	V
All other pins		0 to 5.5	V
Junction Temperature Range		-40 to 125	°C
Ambient Temperature Range		-40 to 85	°C



# DIO7003

5.5V Low Loss Power Distribution Switch

## Electrical Characteristics

$T_A=25^{\circ}\text{C}$   $V_{IN} = 5\text{V}$ , unless otherwise noted.

Symbol	Parameter	Conditions	Min.	Typ.	Max.	Unit
$V_{IN}$	Input Voltage Range		2.7		5.5	V
$I_{SHDN}$	Shut down Input Current	Open load, IC Disabled		0.2	1	$\mu\text{A}$
$I_Q$	Quiescent Supply Current	Open load, IC Enabled		50	88	$\mu\text{A}$
$R_{DS(ON)}$	FET $R_{ON}$	$I_{OUT} = 100\text{mA}$		75	99	m $\Omega$
$V_{EN(H)}$	EN Rising Threshold	$V_{IN} = 2.7\text{V to } 5.5\text{V}$	1.4			V
$V_{EN(L)}$	EN Falling Threshold	$V_{IN} = 4.5\text{V to } 5.5\text{V}$			0.6	V
		$V_{IN} = 2.7\text{V to } 4.5\text{V}$			0.5	
$I_{EN}$	EN Leakage Current	$V_{EN} = 5.0\text{V}$			1	$\mu\text{A}$
$V_{IN\_UVLO}$	IN UVLO Threshold				2.5	V
$V_{IN\_HYS}$	IN UVLO Hysteresis			240	400	mV
$I_{LIM}$	Current Limit	DIO7003HA, DIO7003LA	0.375	0.5	0.625	A
		DIO7003HB, DIO7003LB	0.75	1	1.25	
		DIO7003HC, DIO7003LC	1.1	1.5	1.9	
		DIO7003HD, DIO7003LD	1.5	2	2.5	
		DIO7003HE, DIO7003LE	2.1	2.5	3.1	
$I_{OS}$	Short Current Limit			$I_{LIM,Typ} \times 1.2$	$I_{LIM,Max} \times 1.2$	A
$T_{ON}$	Turn-on Time	$R_L=10\Omega, C_{OUT}=1\mu\text{F}$		400		$\mu\text{s}$
$T_{OFF}$	Turn-off Time	$R_L=10\Omega, C_{OUT}=1\mu\text{F}$		20		$\mu\text{s}$
$T_{SD}$	Thermal Shut down Temperature			140		$^{\circ}\text{C}$
	Thermal Shut down Hysteresis			20		$^{\circ}\text{C}$

## Block Diagram

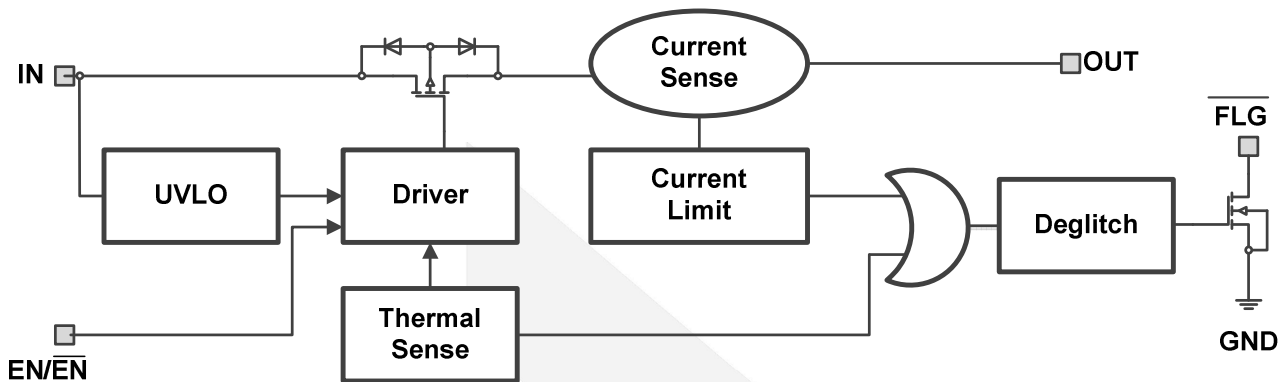

## Application Information

### Power Supply Considerations

A 10 $\mu$ F ceramic capacitor from  $V_{IN}$  to GND to prevent the input voltage from dropping during the hot-plug condition is strongly recommended. However higher capacitance could help reduce the voltage drop. Further more, bypassing the output with a 10 $\mu$ F ceramic capacitor improves the immunity of the device to short-circuit transients, because an output short will cause ringing on the input without the input capacitor. It could destroy the internal circuitry when the input transient voltage exceeds the absolute maximum supply voltage even for a short duration.

### Under Voltage Lockout

A voltage sense circuit monitors the input voltage. When the input voltage is below approximately 2.4V, a control signal turns off the power switch.

### Enable

The logic enable controls the power switch, the bias for the charge pump, driver, and other circuitry to reduce the supply current. The EN control pin must be driven to a logic high or logic low for a clearly defined signal input. Floating these control lines may cause unpredictable operation.

### Over-Current Protection

The DIO7003 responds to over current conditions by limiting output current to the  $I_{LIM}$  levels. When an over current condition is detected, the device maintains a constant output current and reduces the output voltage accordingly. Complete shut down occurs only if the fault is present long enough to activate thermal limit.

Two possible overload conditions can occur. In the first condition, an excessive load occurs while the device is enabled. When the excessive load occurs, very high currents may flow for a short time before the current limit circuit can react. After the current limit circuit has tripped (reached the overcurrent trip threshold) the device switches into constant current mode to limit the current close to  $I_{LIM}$ .

In the second condition, the load is gradually increasing beyond the recommended operating current. The current is permitted to rise until the currentlimit threshold ( $I_{LIM}$ ) is reached or until the thermal limit of the device is



## DIO7003

exceeded. The DIO7003 is capable of delivering current up to the current limit threshold ( $I_{LIM}$ ) without damaging the device. Once the threshold has been reached, the device switches into its constant current mode.

### Thermal Protection

Thermal protection prevents damage to the IC when heavy overload or short circuit conditions are present for extended periods of time. The conditions force the DIO7003 into constant current mode, and under short circuit conditions, the voltage across the switch is equal to the input voltage. The increased dissipation causes the junction temperature to rise to high levels. The protection circuit senses the junction temperature of the switch and shuts it off. Hysteresis is built into the thermal sense circuit, and after the device has cooled approximately 20 degrees, the switch turns back on. The switch continues to cycle in this way until the overload or input power is removed.

### Reverse-voltage Protection

The reverse-voltage protection feature turns off the P-channel MOSFET whenever the output voltage exceeds the input voltage by 175mV (typ) for 4ms (typ). A reverse current of  $(V_{OUT}-V_{IN})/R_{DS(on)}$  will be present when this occurs. This prevents damage to devices on the input side of the DIO7003 by preventing significant current from sinking into the input capacitance. The DIO7003 devices allow the P-channel MOSFET to turn on once the output voltage goes below the input voltage for the same 4ms deglitch time.

### FLG Output

An error Flag is an open-drained output of an N-channel MOSFET. Flag output is pulled low when the below conditions happen: input under voltage lockout, output current limit, output short circuit and over temperature shut down. The flag response delay time is 5ms typically.







# DIO7003

5.5V Low Loss Power Distribution Switch

## Typical Performance Characteristics

T<sub>A</sub>=25°C V<sub>IN</sub> = 5V, unless otherwise noted.

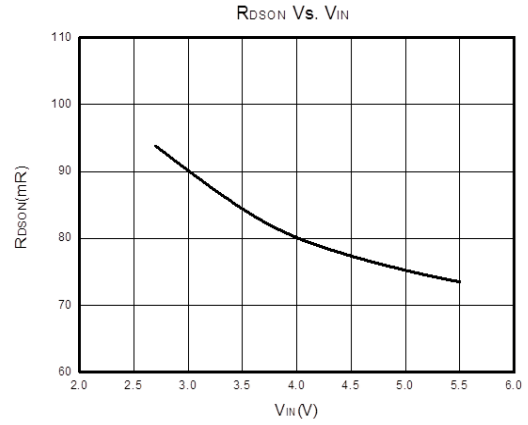
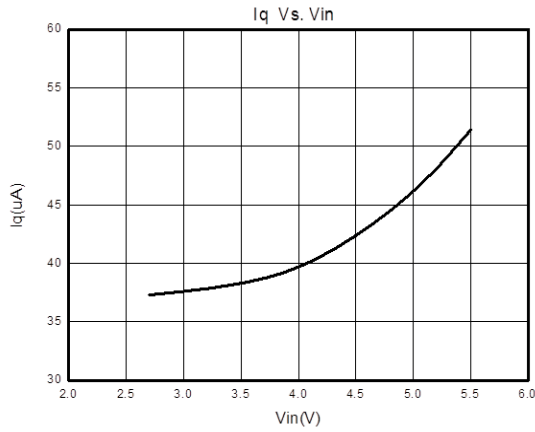

Current Limit

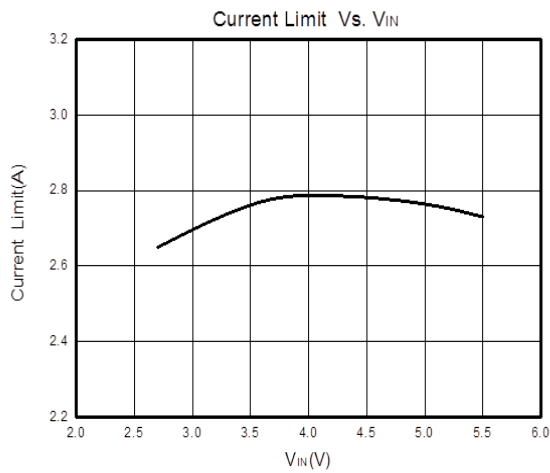

Output Short Response



EN Turn On  
(I<sub>load</sub>=0.7A, V<sub>in</sub>=5V, R=7ohm)

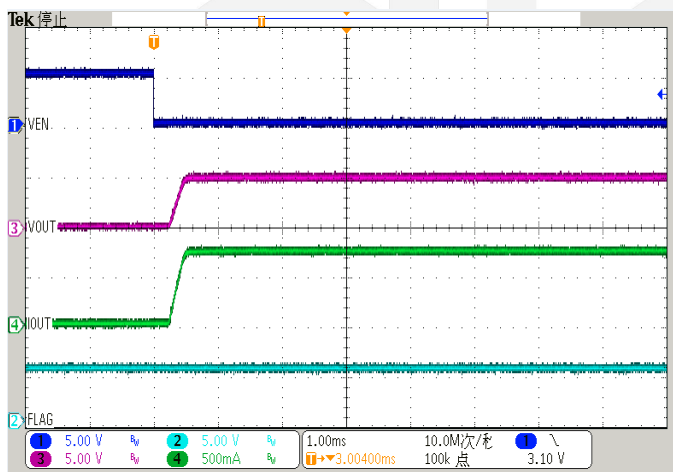

EN Turn Off  
(I<sub>load</sub>=0.7A, V<sub>in</sub>=5V, R=7ohm)

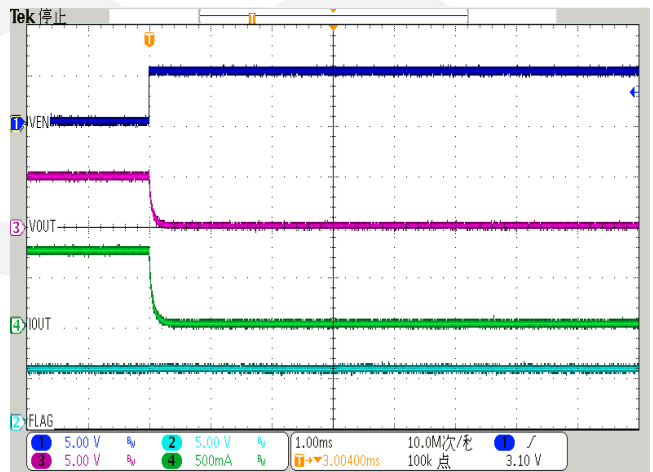

UVLO Turn On  
(Iload=0.7A, Vin=5V, R=7ohm)

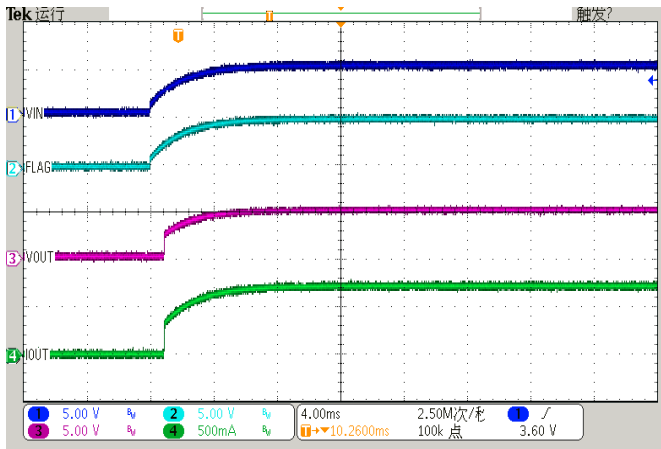

UVLO Turn Off  
(Iload=0.7A, Vin=5V, R=7ohm)

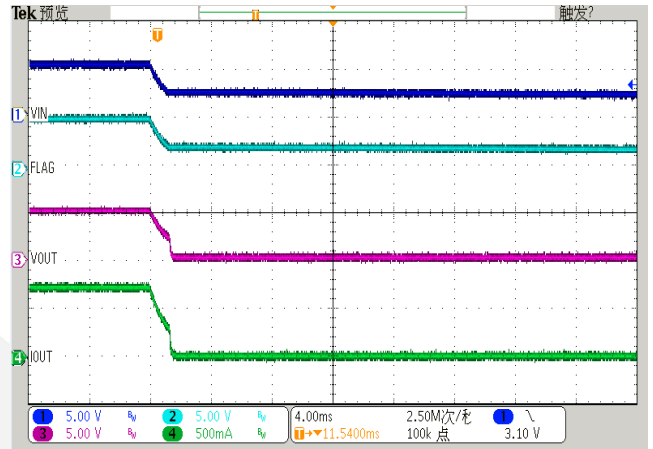

No-Load to Over-Load Transient Response  
(Vin=5V, R=1ohm)

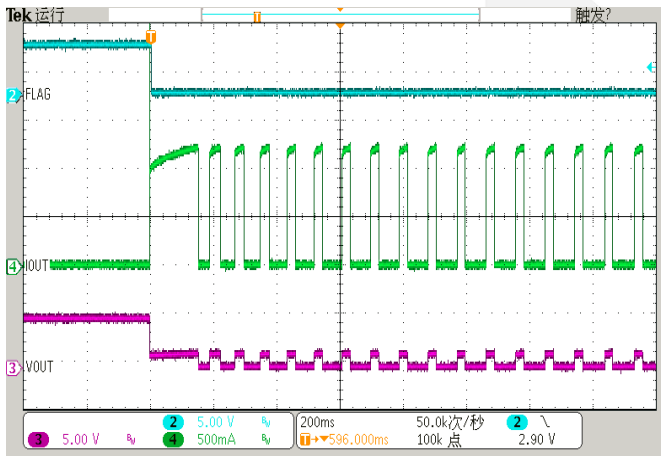

Over-Load to No-Load Recovery Response  
(Vin=5V, R=1ohm)

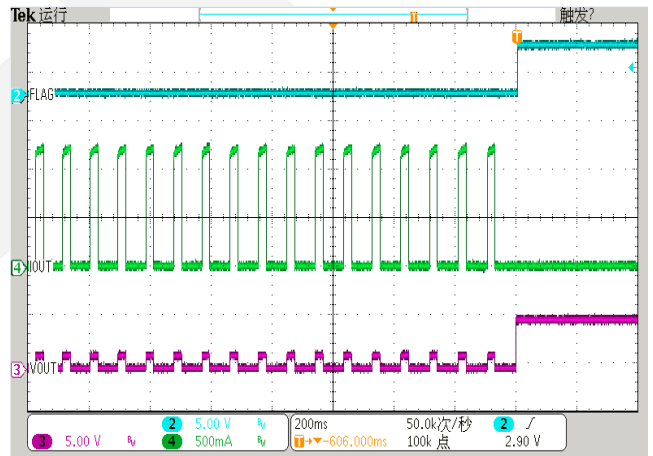

Full-Load to Short-Circuit Transient Response  
(Iload=0.7A, Vin=5V)

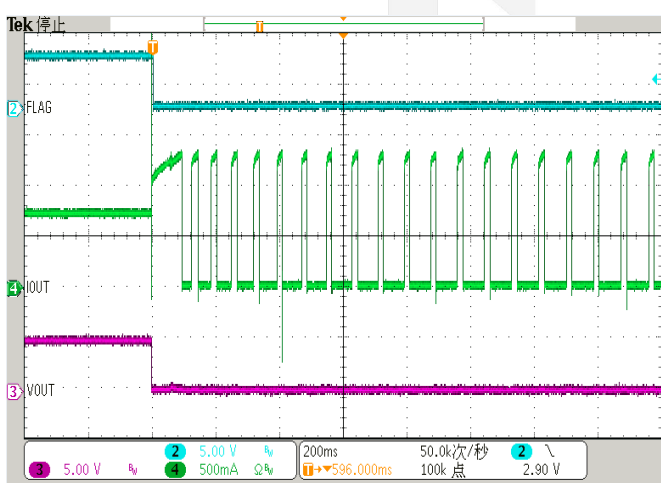

Short-Circuit to Full-Load Recovery Response  
(Iload=0.7A, Vin=5V)

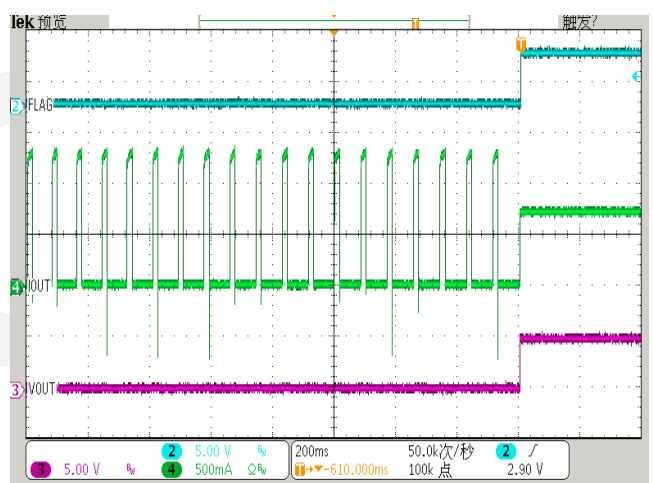



# DIO7003

5.5V Low Loss Power Distribution Switch

No-Load to Short-Circuit Transient Response  
(Vin=5V)

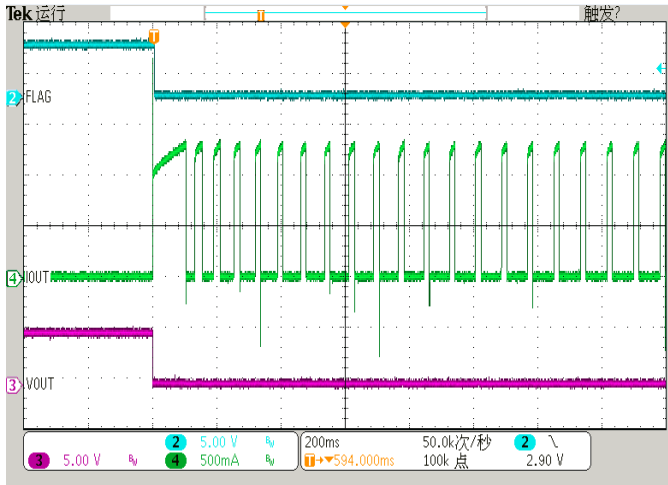

Short-Circuit to No-Load Recovery Response  
(Vin=5V)

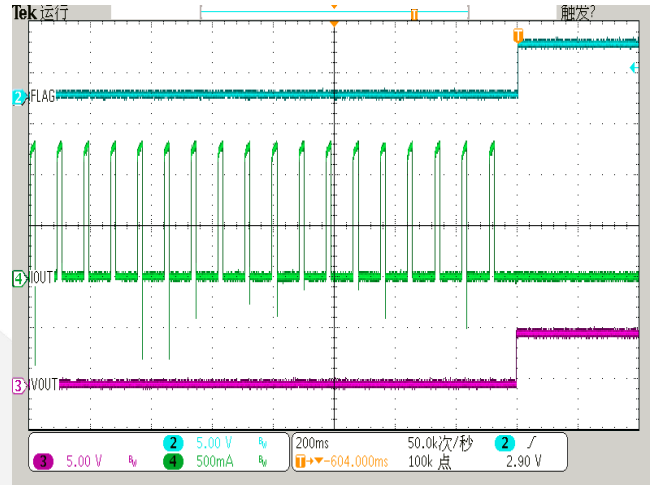



DIO7003

5.5V Low Loss Power Distribution Switch

## CONTACT US

Dioo is a professional design and sales corporation for high-quality and performance analog semiconductors. The company focuses on industry markets, such as, cell phone, handheld products, laptop, and medical equipment and so on. Dioo's product families include analog signal processing and amplifying, LED drivers and charger IC. Go to <http://www.dioo.com> for a complete list of Dioo product families.

For additional product information, or full datasheet, please contact with our Sales Department or Representatives.



# Mouser Electronics

Authorized Distributor

Click to View Pricing, Inventory, Delivery & Lifecycle Information:

## DIOO:

[DIO7003XYST5](#) [DIO7003HAMP8](#) [DIO7003HDMP8](#) [DIO7003LCSO8](#) [DIO7003LCMP8](#) [DIO7003HBSO8](#)  
[DIO7003HCST5](#) [DIO7003HBST5](#) [DIO7003LEMP8](#) [DIO7003HCSO8](#) [DIO7003LBMP8](#) [DIO7003LCST5](#)  
[DIO7003HCMP8](#) [DIO7003HASO8](#) [DIO7003LBSO8](#) [DIO7003HDST5](#) [DIO7003LBST5](#) [DIO7003LDSO8](#)  
[DIO7003LESO8](#) [DIO7003HBMP8](#) [DIO7003LASO8](#) [DIO7003HEMP8](#) [DIO7003HEST5](#) [DIO7003LAST5](#)  
[DIO7003XYSO8](#) [DIO7003HAST5](#) [DIO7003LAMP8](#) [DIO7003LDMP8](#) [DIO7003XYMP8](#) [DIO7003HDSO8](#)  
[DIO7003HESO8](#) [DIO7003LDST5](#) [DIO7003LEST5](#)